

**Special Roads Programme 2010-11
Kalappanaickenpatty Town Panchayat
Tender Notice**

**Improvement/Laying of Cement Concrete Pavement
Form of contract: Item rate (Two cover system)**

1. Bids are invited in packages for the Improvement/Laying of Cement Concrete Pavement, in 541 Town Panchayats of Tamil Nadu (Two cover system) under the "Special Roads Programme 2010-11".
2. The bid documents will be available from 14.10.2010. The bid document can be downloaded from the website <https://tntenders.gov.in> , and <http://townpanchayats.tn.gov.in/tender> at free of cost.
3. Tender documents can be downloaded upto 3.00 PM on 01.11.2010. Online submission of tender will also be accepted.
4. Amount of Earnest Money Deposit will be 1% of the value put to tender for a package.
5. Period of contract is 6 months.
6. Any additional / further details and conditions related to these works can be had from the office of the respective Executive Officers of Town Panchayats
7. Important dates

1	Date and time of Pre bid meeting	22 .10. 2010 AT 11.00 AM
2	Last date and time for downloading bid documents	01. 11. 2010 AT 3.00PM
3	Last Date and time for submission of bid document, including online submission	01. 11. 2010 AT 3.00PM
4	Date and time of opening of the Technical Bid	01. 11. 2010 AT 3.30PM

8. In the event of specified date for submission of bids is declared a holiday, bids will be received and opened on the next working day at the same time and venue.

9. Other details can be seen in the bid documents.

Executive Officers of Town Panchayat

Tender Document
“Special Roads Programme 2010-11 ”
TECHNICAL BID

Kalappanaickenpatty Town Panchayat

NAME OF THE WORK : Providing Cement Concrete Pavement for the cross streets (1) Kalappanaickenpatty Pudur, Vettuvagoundar Street, (2) Pudur Reddy Colony, (3) Thottiyapatty Arunthathiyar Street and Thottiyar Street at Kalappanaickenpatty Town Panchayat in Namakkal District. **(Package No:1)**”in Kalappanaickenpatty Town Panchayat **Value Put to Tender Rs.26.91 Lakhs**

E.M.D.AMOUNT : Rs.26910/-

xPERIOD OF DOWN : UPTO 15:00 HRS 01.11.2010

LOADING OF BID DOCUMENT

LAST DATE AND TIME FOR RECEIPT OF BID : DATE 01.11.2010 TIME : 15.00 HRS

TIME AND DATE OF OPENING OF BIDS : DATE 01.11.2010 TIME : 15.30 HRS

PLACE OF OPENING OF BIDS : **Kalappanaickenpatty
Town Panchayat**

OFFICER INVITING BIDS : Executive Officer
Kalappanaickenpatty Town Panchayat
Namakkal District.

CHECK LIST FOR SUBMISSION OF BID

Bidder shall check the submission of relevant details and documents as mandated in the tender document, before submission of bids.

Sl.No.	Compliance criteria as per clause	Details	Check
1	15. 15.1	Earnest Money Deposit Whether Earnest Money Deposit at 1% of the contract value of work put to tender in the form of Banker's cheque, Demand Draft enclosed? (EMD in any other form will not be accepted)	YES / NO
2	4.1.A.1	Whether copy of Certificate of registration as class II contractor and above, with proof for its currency enclosed?	YES / NO
3	4.1.A.2	Whether Proof for being in the Civil Engineering construction field at-least for the past Five year (2005-06 to 2009-10) enclosed?. [Bidder should submit the audited balance sheet for the last five years.]	YES / NO
4	4.1.A.3	Whether Proof for having an annual minimum financial turnover of not less than 50% of the value put to tender in a financial year in the preceding "Three" years (2007-08,08-09,09-10) enclosed?	YES / NO
5	4.1.A.4	Whether proof for having satisfactorily completed BT or BTand CC Road Work(s) of not less than 50% of the value put to tender under a "single agreement" in any one of the preceding three years (2007-08, 08-09, 09-10) for Government Department/Board/Government Undertaking enclosed?	YES/NO
6	4.1.A.5	Whether Proof of the applicant for having working capital sufficient to finance at least 15% of value put to tender enclosed? [Working capital will be calculated by adding the amount available in the bank account of the applicant on the date of submission of application for the unutilized amount of overdraft / credit facility extended to the applicant by the Nationalized / Scheduled banks]	YES/NO
7	4.1.B	Whether all the certificates are Notorised?	YES/NO
8	4.1.C & D	<i>Whether the proof/details of availability of Contractor's Major Equipments proposed for carrying out the works enclosed? [If the contractor for BT road works does not own Paver Machine and Hot mix plant, lease agreement as prescribed in tender document enclosed]</i>	YES/NO
9	General	Whether the latest TIN return enclosed ?	YES / NO
10	Section 2	Whether Annexure A to H have been enclosed duly filled in?	YES / NO

11	General	Whether Power of attorney / Authorization for	
		•Persons signing the Tender enclosed?	YES / NO
		•For Partner – in- charge if any,	YES / NO
12	SECTION 2	Whether Qualification Information are annexed in the prescribed forms A to H ?	
		Annexure A	Yes/No
		Annexure B	Yes/No
		Annexure C	Yes/No
		Annexure D	Yes/No
		Annexure E	Yes/No
		Annexure F	Yes/No
		Annexure G	Yes/No
		Annexure H	Yes/No
13		Whether the bidder has signed in all the pages of the tender document?	Yes /No
14	D. 18.1 and 18.2	Sealing and Marking of Bids in case of manual submission	
		a. Whether the cover containing EMD, VAT clearance certificate, qualification and information etc., has been super scribed as “Technical Bid”?	Yes/No
		b. Whether the other cover containing the duly filled in tender schedule is super scribed as “Price Bid”?	Yes/No
		c. Whether the bids are put in 2 separate covers and outer cover is sealed?	Yes/No
		d. Whether both these covers are put in a single big envelope and bear the following identification:	Yes/No
		<p>“Tender for Improvement/Laying of Cement Concrete Pavement (Package No:1)” in Kalappanaickenpatty Town Panchayat</p> <p>Bid Reference No.295/2010-11</p> <p>DO NOT OPEN BEFORE 15.30 hours on 01.11.2010</p>	

Disclaimer: This Check list is only illustrative and not exhaustive. Hence, the bidder is requested to go through the entire Document and submit all relevant documents and details.

INVITATION FOR BID
(IFB)

SECTION -1
INSTRUCTIONS TO BIDDERS (ITB)

SECTION -1

INSTRUCTIONS TO BIDDERS (ITB)

Table of Clauses

Clause	A. General	Page No.	Sl. No.	E. Bid Opening and Evaluation	Page No.
1	Scope of Bid	07	22	Bid Opening	12
2	Source of funds	07	23	Examination of Bids and Determination of Responsiveness	13
3	Eligible bidders	07	24	Price Bid Opening	13
4	Qualification of the bidder	07	25	Process to be confidential	13
5	Cost of Bidding	08	26	Clarification of bids	13
6	Site Visit	08	27	Correction of errors	13
			28	Evaluation and comparison of bids	14
				F. Award of Contract	
B. Bidding Documents			29	Award Criteria	14
7	Content of Bidding Documents	09	30	Employers right to accept any Bid and to Reject any or all Bids	14
8	Clarification on Bid Documents	09	31	Notification of Award and signing of agreement	14
9	Amendment to Bid Documents	09	32	Corrupt or Fraudulent Practices	15
C. Preparation of Bids			33	Procedure for e submission	15
10	Language of Bid	09			
11	Documents Comprising the Bid	09			
12	Bid Prices	10			
13	Currencies of Bid and Payment	10			
14	Bid Validity	10			
15	Earnest Money Deposit	10			
16	Alternative Proposals by Bidders	11			
17	Format and Signing of Bid	11			
D. Sealing of Bids					
18	Sealing and Marking of Bids	11			
19	Deadline for Submission of Bids	12			
20	Late Bids	12			
21	Withdrawal of Bids	12			

A. General

1. Scope of Bid

1. The Executive officer Kalappanaickenpatty Town Panchayat (referred to as Employer in these documents) invites bids for the works (as defined in these documents and referred to as "the works") detailed in the table given in IFB.
- 1.2 The successful bidder will be expected to complete the works by the intended completion date specified in the Contract data.

2. Source of Funds

Under the "Special Roads Programme 2010-11" – Government of Tamil Nadu has allotted funds for Implementation of Improvement/Laying of Cement Concrete Pavement (Package No:1)" of Kalappanaickenpatty Town Panchayat.

3. Eligible Bidders

- 3.1 All bidders shall furnish their qualification details in Section 3 based on which eligibility will be decided
- 3.2 Bidders shall not be under a declaration of ineligibility for corrupt and fraudulent practices.

4. Qualification of the Bidders

- 4.1 A.
 - 1) The Bidder should be at least a CLASS II contractor, currently registered with any State Government Department/Board/Government Undertaking.
 - 2) The Applicants should have been in the Civil Engineering Construction field at-least for the past Five years. (2005-06 to 2009-10). He should submit the audited balance sheet for last five years.
 - 3) Should have an annual minimum financial turnover of not less than 50% of the value put to tender in a financial year in the preceding "Three" years (2007-08,08-09,09-10)
 - 4) Satisfactorily completed BT (or) BT and CC Road work(s) of not less than 50% of the value put to tender under a "single agreement" in any one of the preceding "three" years (2007- 08,08-09,09-10)for Government Department/Board/Government Undertaking
 - 5) The applicant should have working capital sufficient to finance at least 15% of value put to tender. [Working capital will be calculated by adding the amount available in the bank account of the applicant on the date of submission of application and the unutilized amount of overdraft / credit facility extended to the applicant by the Nationalized / Scheduled banks]
- B) **All copy of certificates in support of the above should be attested by Notary Public / Officers not below the rank of Executive Engineer**
- C) **Each bidder should further demonstrate:**

The tenderers shall have the following minimum construction equipments Tools and Plants exclusively available for this work. – (Either own or under lease with the applicant)

SI No	Name of the Equipment	Quantity
	For CC Roads	
1	Concrete Mixers Or Mobile Batching Plant	3 Nos 1 No.
2	Screed Vibrator	2 No.
3	Water Lorry	1 No.

For B.T Roads		
1	Central Mixing Plant	1 No.
2	Paver Machine	1 No.
3	Tipper Lorry	4 Nos.
4	Vibratory Roller	1 No.
5	Static Roller	1 No.
6	Vehicle Mounted Mechanical Sprayer	1 No.
7	Water Lorry	2 Nos.
Embankment		
1	Chain Dozer	1 No.
2	Excavator	1 No.
3	Loader	1 No.
4	Water Lorry	1 No.
5	Roller 8 -10 Tonne	1 No.

D) Evidence to be produced:

- i. OWNERSHIP of the Paver machine or its LEASE from a lawful owner for use at any time during the period of contract is a must. If the bidder owns a Paver machine, he should furnish a copy of the RC book of the Paver machine, duly attested by a Notary Public, as proof of title. If the bidder is leasing in a Paver machine, he should furnish (i) a copy of the RC book of the lessor's Paver machine, duly attested by a Notary Public, as proof of title of the lessor and (ii) the original of an agreement with the lessor with 2 independent witnesses and duly attested by a Notary Public on Rs20/- value non judicial stamp paper allowing the use of the Paver machine at any time during the period of contract. Non production of any of these documents shall result in summary rejection of the bid.
- ii. The bidder should either furnish proof of ownership of a Hot mix plant or a letter from a Hot mix plant operator for showing a firm tie-up arrangement for the supply of Hot mix required for the contract. The Hot mix shall be delivered at the work site at 120°C
- iii. Sworn in Affidavit and Chartered Accountant's Certificate stating the details of equipments, tools and plants available with the applicant with make, year of purchase, capacity, present working condition of the equipment etc.,
If the Tools and plants are proposed to be taken on lease or already on lease with the applicant, the source, from which the Tools and plants have been taken on lease or proposed to be taken on lease with proof, should be furnished

4.2 Even though the bidders meet the qualifying criteria, they will be disqualified if they have:

- a) made misleading or false representations in the forms, statements and attachments submitted in proof of the qualification requirements; and/or
- b) record of poor performance such as abandoning the works, not properly completing the contract, inordinate delays in completion, litigation history, or financial failures etc.;

5 Cost of Bidding

5.1 The bidder shall bear all costs associated with the preparation and submission of his Bid, and the Employer will in no case be responsible and liable for those costs.

6 Site visit

6.1 The Bidder, at the Bidder's own responsibility and risk is encouraged to visit and examine the Site of Works and its surroundings and obtain all information that may be necessary for preparing the Bid and entering into a contract for construction of the Works. The cost of visiting the Site shall be at the Bidder's own expense.

B. Bid Documents

7. Content of Bid Documents

- 7.1 The set of bid documents comprises of the documents listed in the table below and addenda issued in accordance with Clause (if any)

Invitation for Bids		
Section	1	Instructions to Bidders
	2	Forms of Bid and Qualification Information
	3	Conditions of Contract
	4	Bill of Quantities

8. Clarification on Bid Documents

- 8.1 A prospective bidder requiring any clarification of the bidding documents may notify Executive Officer in writing or by cable (hereinafter "cable" includes telex and facsimile) at the Employer's address indicated in the invitation to bid. The Executive officer will respond to any request for clarification which he received earlier than 48 hours prior to the opening of the tender.
- 8.2 The Executive Officer will hold pre-bid meeting for the work. Clarification can also be obtained during the meeting to be held on 22.10.2010 at 11:00 AM at the Town Panchayat Office.

9. Amendment to Bid Documents

- 9.1 At any time after the issue of the tender documents and before the opening of the tender, the Tender Inviting Authority may make any changes, modifications or amendments to the tender documents. All such changes will also be uploaded in the relevant websites.
- 9.2 Any addendum/ corrigendum thus issued shall be part of the bidding documents and shall be communicated in writing or by cable to all the purchasers of the bidding documents. Prospective bidders shall acknowledge receipt of each addendum by cable to the Employer.
- 9.3 To give prospective bidders reasonable time in which to take an addendum into account in preparing their bids, the Employer shall extend as necessary the deadline for submission of bids, in accordance with Sub-Clause 19.2 below.

C. Preparation of Bids

10. Language of the Bid

- 10.1 All documents relating to the bid shall be in the English language.

11. Documents comprising the Bid

- 11.1 The bid submitted by the bidder shall comprise the following documents:

- (a) The Bid (in the formats indicated in Section 3).
- (b) Earnest Money Deposit (EMD)
- (c) Priced Bill of Quantities;
- (d) Qualification Information Form and Documents;
- (e) Exemption from EMD, if any, claimed by the bidder

and any other materials required to be completed and submitted by bidders in accordance with these instructions. The documents listed under sub-clause, 4 , 6 and 7.1 of section 1 and section 3 shall be filled in without exception.

12. Bid Prices

- 12.1** The contract shall be for the whole works as described in Sub-Clause 1.1, based on the priced Bill Quantities submitted by the Bidder.
- 12.2** The bidder shall fill in rates and prices and line item total (both in figures and words) for all items of the Works described in the **Bill of Quantities** along with total bid price (both in figures and words). Items for which no rate or price is entered by the bidder will not be paid for by the Employer when executed and shall be deemed covered by the other rates and prices in the Bill of Quantities. Corrections, if any, shall be made by crossing out, initialing, dating and rewriting.
- 12.3** All duties, taxes, and other levies payable by the contractor under the contract, or for any other Act /Rules/Stipulations shall be included in the rates, prices and total Bid Price submitted by the Bidder.

13. Currencies of Bid and Payment

- 13.1** The unit rates and the prices shall be quoted by the bidder entirely in Indian Rupees.

14. Bid Validity

- 14.1** Bids shall remain valid for a period not less than **ninety days** after the deadline date for bid submission specified in Clause 19. A bid valid for a shorter period shall be rejected as non-responsive.
- 14.2** In exceptional circumstances, prior to expiry of the original time limit, the Employer may request that the bidders to extend the period of validity for a specified additional period. The bidder shall consider the same for a period not exceeding additional **thirty days**.
- 14.3** Bid evaluation will be based on the bid prices without taking into consideration the above correction.

15. Earnest Money Deposit

- 15.1** The Bidder shall furnish, as part of his Bid, Earnest Money Deposit at 1% rounded off to next ten rupees of the contract value of work put to tender in the form of Banker's cheque, Demand Draft Drawn in favour of Executive Officer, Kalappanaickenpatty Town Panchayat payable at Kalappanaickenpatty EMD remitted in any other form will not be accepted.
- 15.2** Any bid not accompanied by an acceptable EMD and not secured as indicated in Sub-Clauses 15.1 above shall be rejected by the Employer as non-responsive.
- 15.3** The EMD of unsuccessful bidders will be returned within 28 days of the end of the bid validity period specified in Sub-Clause 14.1.
- 15.4** The EMD may be forfeited
- (a) if the Bidder withdraws the Bid after Bid opening during the period of Bid validity;
 - (b) if the Bidder does not accept the correction of the Bid Price, pursuant to Clause 27; or
 - (c) in the case of a successful Bidder, if the Bidder fails within the specified time limit to enter into an agreement

16. No Alternative Proposals by Bidders

16.1 Bidders shall submit offers that comply with the requirements of the bidding documents, including the basic technical design as indicated in the drawing and specifications. No alternatives will be considered.

17. Format and Signing of Bid

17.1 The Bid shall be typed or written in indelible ink and shall be signed by a person or persons duly authorized to sign on behalf of the Bidder. All pages of the bid where entries or amendments have been made shall be initialed by the person or persons signing the bid.

17.2 The Bid shall contain no alterations or additions, except those to comply with instructions issued by the Employer, or as necessary to correct errors made by the bidder, in which case such corrections shall be initialed by the person or persons signing the bid.

17.3 The Bidder shall furnish information as described in the Form of Bid on commissions or gratuities, if any, paid or to be paid to agents relating to this Bid, and to contract execution if the Bidder is awarded the contract.

17.4 E-Submission of tender is also accepted.

D. Submission of Bids

18. Sealing and Marking of Bids

18.1 The intending bidder should submit tender in two cover system. The cover containing EMD, VAT clearance certificate, qualification and information etc., shall be superscribed as "Technical Bid". Another cover containing the duly filled in tender schedule shall be superscribed as "Price Bid". Both these covers shall be put in a single big envelope and shall be submitted.

The Cover superscribed as "Technical Bid" will be opened first. The Price Bid cover will be opened only if the document required in the Technical Bid cover viz., EMD, VAT clearance certificate, work experience EMD exemption certificate(if applicable), etc., are found in order as per the tender conditions. If Technical Bid is not submitted with these particulars, the Price Bid cover will not be opened and the tender will be rejected and returned to the bidder "unopened".

18.2 The **inner and outer** envelopes shall

(a) be addressed to the Employer at the following address:
The Executive Officer,
Kalappanaickenpatty Town Panchayat

(b) bear the following identification:

- **"Tender for Improvement/Laying of Cement Concrete Pavement (Package No:1)"** in Kalappanaickenpatty Town Panchayat
- Bid Reference No.295/ 2010-11
- **DO NOT OPEN BEFORE 15.30 hours on 01.11.2010**

18.3 In addition to the identification required in Sub-Clause 18.2, the inner envelopes shall indicate the name and address of the bidder to enable the bid to be returned unopened in case it is declared late, pursuant to Clause 20.

18.4 If the outer envelope is not sealed and marked as above, the **Tender Inviting Authority** will assume no responsibility for the misplacement or premature opening of the bid.

19. Deadline for Submission of the Bids

- 19.1** Bids must be received by the **Tender Inviting Authority** at the address specified above not later than **15.00** hours on **01.11.2010** . In the event of the specified date for the submission of bids is declared a holiday, the Bids will be received upto the appointed time on the next working day.
- 19.2** The **Executive Officer** may extend the deadline for submission of bids by issuing an amendment in accordance with Clause 9, in which case all rights and obligations of the Employer and the bidders previously subject to the original deadline will then be subject to the new deadline.

20. Late Bids

- 20.1** Any Bid received by the **Tender Inviting Authority** after the deadline prescribed in Clause 19 will be returned unopened to the bidder.

21. Withdrawal / Modification of Bids

- 21.1** Bidders may modify or withdraw their bids by giving notice in writing before the deadline prescribed in Clause 19.
- 21.2** Each Bidder's withdrawal notice shall be prepared, sealed, marked, and delivered in accordance with Clause 17 & 18, with the outer and inner envelopes additionally marked "**WITHDRAWAL**".
- 21.3** No bid may be modified after the deadline for submission of bids.
- 21.4** Withdrawal or modification of a Bid between the deadline for submission of bids and the expiry of the original period of bid validity specified in Clause 14.1 above or as extended pursuant to Clause 14.2 may result in the forfeiture of the Bid security pursuant to Clause 15.
- 21.5** Bidders may offer discount to or modify the prices of the bids by submitting the bid modifications in accordance with this clause, or include in the original bid submission.

E. Bid Opening and Evaluation

22. Bid Opening

- 22.1** The **Tender Inviting Authority** will open all the Bids received (except those received late), including modifications made pursuant to Clause 21, in the presence of the Bidders or their representatives who choose to attend at **15.30** hours on **01.11.2010** at Town Panchayat office. In the event of the specified date of Bid opening being declared a holiday, the Bids will be opened at the appointed time and location on the next working day.
- 22.2** Envelopes marked "**WITHDRAWAL/ MODIFICATION**" shall be opened and read out first. Bids for which an acceptable notice of withdrawal has been submitted pursuant to Clause 21 shall not be opened.
- 22.3** The Bidders' names, the Bid withdrawals/ Modifications, the presence or absence of Bid security, and such other details as the **Tender Inviting Authority** may consider appropriate, will be announced by the **Tender Inviting Authority** at the opening. Bids sent pursuant to Clause 21 that are not opened and read out at bid opening will not be considered for further evaluation regardless of the circumstances. Late and withdrawn bids will be returned un-opened to bidders.
- 22.4** The **Tender Inviting Authority** shall prepare minutes of the Bid opening, including the information disclosed to those present in accordance with Sub-Clause 22.3.

23. Examination of Technical Bids and Determination of Responsiveness

- 23.1** Prior to the detailed evaluation of Technical Bids, the Tender Scrutiny Committee will determine whether each Bid (a) meets the eligibility criteria defined in Clause 22; (b) has been properly signed; (c) is accompanied by the required securities and; (d) is substantially responsive to the requirements of the Bid documents.
- 23.2** A substantially responsive Bid is one which conforms to all the terms, conditions, and specifications of the Bid documents, without material deviation or reservation. A material deviation or reservation is one (a) which affects in any substantial way the scope, quality, or performance of the Works; (b) which limits in any substantial way, inconsistent with the Bidding documents, the Employer's rights or the Bidder's obligations under the Contract; or (c) whose rectification would affect unfairly the competitive position of other Bidders presenting substantially responsive Bids.
- 23.3** If a Bid is not substantially responsive, it will be rejected by the Employer, and may not subsequently be made responsive by correction or withdrawal of the non-conforming deviation or reservation.

24. Price Bid Opening

- 24.1** The **Tender Inviting Authority** shall notify those bidders whose technical bids did not meet the minimum qualification criteria or were considered non responsive, indicating that their price bids will be returned un opened after the award of the contract. The Employer shall simultaneously notify the technically qualified bidders indicating the date time and place set for opening of price bids.
- 24.2** The price bids shall be opened by the **Tender Inviting Authority** in the presence of bidders representatives who choose to attend. The name of the bidders, quoted bid prices, discounts offered or modification if any shall be read aloud and the **Tender Inviting Authority** shall prepare minutes of the price bid opening.

25. Process to be Confidential

- 25.1** Information relating to the examination, clarification, evaluation, and comparison of Bids and recommendations for the award of a contract shall not be disclosed to Bidders or any other persons not officially concerned with such process until the award to the successful Bidder has been announced. Any effort by a Bidder to influence the **Tender Inviting Authority** processing of Bids or award decisions may result in the rejection of his Bid.

26. Clarification of Bids

- 26.1** To assist in the examination, evaluation, and comparison of Bids, bidder may be asked to clarify Bid, including breakdowns of the unit rates. The request for clarification and the response shall be in writing or by cable, but no change in the price or substance of the Bid shall be sought, offered, or permitted except as required to confirm the correction of arithmetic errors discovered by the **Tender Scrutiny Committee** in the evaluation of the Bids in accordance with Clause 27.
- 26.2** Subject to sub-clause 26.1, no Bidder shall contact the **Employer** or his subordinates on any matter relating to its bid from the time of the bid opening to the time the contract is awarded. If the Bidder wishes to bring out additional information, it should be done in writing.
- 26.3** Any effort by the Bidder to influence the **Tender Inviting Authority** or any other person involved in the process of the bid evaluation, bid comparison or contract award decisions may result in the rejection of the Bidders' bid.

27. Correction of Errors

- 27.1** Bids determined to be substantially responsive will be checked by the **Tender Inviting Authority** for any arithmetic errors. Errors will be corrected by the Employer **as follows**:
- (a) where there is a discrepancy between the rates in figures and in words, **the rate whichever is less** will govern; and

- (b) where there is a discrepancy between the unit and the line item total, resulting from multiplying the unit rate by the quantity, the unit rate as quoted will govern.
- 27.2 The amount stated in the Bid will be adjusted by the **Tender Inviting Authority** in accordance with the above procedure for the correction of errors and, with the concurrence of the Bidder, shall be considered as binding upon the Bidder. If the Bidder does not accept the corrected amount the Bid will be rejected and the Bid security may be forfeited in accordance with Sub-Clause 15.4 (b).
- 28. **Evaluation and Comparison of Bids**
- 28.1 The **Tender Inviting Authority** will evaluate and compare only the Bids determined to be substantially responsive in accordance with Clause 23.
- 28.2 In evaluating the Bids, the **Tender Scrutiny Committee** will determine for each Bid the evaluated Bid Price by adjusting the Bid Price as follows:
 - (a) making any correction for errors pursuant to Clause 27; or
 - (b) making an appropriate adjustments for any other acceptable variations, deviations; and
 - (c) making appropriate adjustments to reflect discounts or other price modifications offered in accordance with Sub Clause 21.5.
- 28.3 The **Tender Inviting Authority** reserves the right to accept or reject any variation, deviation, or alternative offer. Variations, deviations, and alternative offers and other factors which are in excess of the requirements of the Bidding documents or otherwise result in unsolicited benefits for the Employer shall not be taken into account in Bid evaluation.
- 28.4. In respect of the successful tenderer, the EMD remitted along with the tender shall be converted as **Security Deposit**. The successful tenderer will be called upon to pay for an amount equivalent to 2% of the contract value (which includes 1% Earnest Money Deposit already paid) within 15 days from the receipt of Letter of Acceptance.

F. Award of Contract

- 29. **Award Criteria**
- 29.1 Subject to Clause 31, the employer will award the Contract to the Bidder whose Bid has been determined to be **substantially responsive to the Bidding documents and who has offered the lowest evaluated Bid Price**, provided that such Bidder has been determined to be (a) eligible in accordance with the provisions of Clause 3, and (b) qualified in accordance with the provisions of Clause 4.
- 30. **Employer 's Right to Accept any Bid and to Reject any or all Bids**
- 30.1 Notwithstanding Clause 29, the Town Panchayat Council reserves the right to accept or reject any Bid, and to cancel the Bidding process and reject all Bids, at any time prior to the award of Contract, without thereby incurring any liability to the affected Bidder or Bidders or any obligation to inform the affected Bidder or Bidders of the grounds for the Employer 's action.
- 30.2 Negotiation of rates will be made only with the lowest Bidder for reducing the quoted rates
- 31. **Notification of Award and Signing of Agreement**
- 31.1 The Bidder whose Bid has been accepted will be notified of the award prior to expiry of the Bid validity period by cable, telex or facsimile confirmed by registered letter. This letter (hereinafter and

in the Conditions of Contract called the "Letter of Acceptance") will state that the sum will be paid to the Contractor in consideration of the execution, completion, and maintenance of the Works by the Contractor as prescribed by the Contract (hereinafter and in the Contract called the "Contract Price").

- 31.2** The notification of award will constitute the formation of the Contract, subject only to the furnishing of an security deposit in accordance with the provisions of Clause 28.4.
- 31.3** The Agreement will incorporate all terms and conditions to be executed between the employer and successful bidder. It shall be signed within 15 days following the issue of Letter of Acceptance and delivered by successful bidder.
- 31.4** Upon the furnishing by the successful Bidder of the Security Deposit, if any the Executive Officer will promptly notify the other Bidders that their Bids have been unsuccessful.

32. Corrupt or Fraudulent Practices

32.1 The Employer requires that Bidders observe the highest standard of ethics during the procurement and execution of such contracts. In pursuance of this policy, the Employer :

- (a) defines, for the purposes of this provision, the terms set forth below as follows :
- (i) "corrupt practice" means the offering, giving, receiving or soliciting of any thing of value to influence the action of a public official in the procurement process or in contract execution; and
- (ii) "fraudulent practice" means a misrepresentation of facts in order to influence a procurement process or the execution of a contract to the detriment of the Borrower, and includes collusive practice among Bidders (prior to or after bid submission) designed to establish bid prices at artificial non-competitive levels and to deprive the Borrower of the benefits of free and open competition or furnishing of false and fabricated documents
- (b) will reject a proposal for award if it determines that the Bidder recommended for award has engaged in corrupt or fraudulent practices in competing for the contract in question:
- i. will declare a firm ineligible, either indefinitely or for a stated period of time, to be awarded a contract if it at any time determines that the firm has engaged in corrupt or fraudulent practices in competing for, or in executing, a Bank-financed contract. Further, Criminal proceedings will also be initiated against the Bidder/ Contractor.

33. Procedure for e submission:

1. Bidder should do the registration in the e – tender site using the option available. Then the Digital signature registration has to be done with the e-token, after logging into the site. The e-token may be obtained from one of the authorized Certifying authorities such as SIFY/TCS/nCode/ SCS/ SGS etc. The list of address of the DSC vendors can be seen in <https://tntenders.gov.in/nicgep>
2. Bidder then should login to the site using user id and the corresponding passwords.
3. The e-token that is registered should be used by the bidder and should not be misused by others.
4. After downloading the tender schedules, the Bidder should go through them carefully and then submit the documents as directed, otherwise, the bid will be rejected.
5. If there are any clarifications, this may be obtained online through the e-tender site, or thro' the contact details. Bidder should take into account the corrigendum published before submitting the bids online.
6. Bidder, in advance, should get ready the bid documents to be submitted as indicated in the tender schedule and they should be in the prescribed format.
7. The bidder should read all the terms & conditions mentioned in the bid document and accept the same to proceed further to submit the bids.

8. The Bidder has to submit the tender document online well in advance before the prescribed time to avoid any delay or problem during the e-submission process.
9. Bidders seeking exemption from payment of EMD, as per existing Government Orders, and choosing e-submission option shall access the relevant option available in the e-submission format and submit scanned copy of related documents without fail.
10. The details of the bid security document should be submitted physically before the opening the tender. The scanned copies furnished at time of e-submission and the original bid security should be the same otherwise the tender will be summarily rejected.
11. The Executive officer, Town Panchayat will not be held responsible for any sort of delay or the technical difficulty faced in the submission of tenders online by the bidders.
12. The bidder may also submit the bid documents by online mode through the site (<https://tntenders.gov.in>)
13. The tendering system will give an ACKNOWLEDGEMENT Message only after successful uploading of all the required bid documents. The ACKNOWLEDGEMENT is the bid summary. With the Bid No., Date & Time of submission of the bid with all other relevant details. The documents submitted by the bidders will be digitally signed with the e-token of the bidder and then submitted.
14. The ACKNOWLEDGEMENT should be printed and to be kept as a token of the submission of the bid. The ACKNOWLEDGMENT will act as a proof of bid submission for a tender floated and will also act as an entry point to participate in the bid opening date.
15. Bidder should log into the site well in advance for bid submission so that he submits the bid in time i.e. on or before the bid submission time. If there is any delay, due to other issues, bidder only is responsible.
16. Each document to be uploaded thro' online for the tenders should be less then 2 MB, If any document is more than 2 MB, it can be reduced through zip format and the same can be uploaded. It may be however noted that. If the file size is less than 1MB the transaction uploading time will be very fast.
17. The time setting fixed in the server side & displayed at the top of the tender site, will be valid for all actions of requesting, bid submission, bid opening etc., in the e-tender system. The bidders should follow this time only, during bid submission.
18. All the data being entered by the bidders would be encrypted using PKI encryption techniques to ensure the secrecy of the data. The data entered will not be viewable by unauthorized persons during bid submission & not be viewable by anyone until the time of bid opening. Overall, the submitted tender documents become readable only after the tender opening by the authorized individual.
19. The Confidentiality of the bids is maintained since the secured Socket layer 128 bit encryption technology is used. Data storage encryption of sensitive fields is done.
20. The bidders are requested to upload all related documents through e-tendering on line system to the tender inviting authority **well before 15.00 hours**(as per Server System Clock) on **01.11.2010**
21. Tenders will be opened by the Tender inviting authority or his authorized officer(s) at 3.30 P.M. on 01.11.2010 in the presence of tenders or their authorized representatives if any & members of Tender Scrutiny Committee.

SECTION 2

ADDITIONAL CONDITIONS OF CONTRACT

SECTION 2

ADDITIONAL CONDITIONS OF CONTRACT

Table of Contents

Sl. No.	Description	Page No.	Sl. No.	Description	Page No.
	A. General			C. Quality Control	
1	Definitions	19	23	Identifying Defects	23
2	Interpretation	20	24	Tests	23
3	Language and Law	20	25	Correction of Defects	24
4	Engineer's Decisions	20	26	Uncorrected Defects	24
5	Delegation	20		D. Cost Control	
6	Communications	20	27	Bill of quantities	24
7	Other Contractors	21	28	Payments	24
8	Personnel	21	29	Tax	24
9	Employer's and Contractor's Risks	21	30	Currencies	24
10	Employer's Risks	21	31	Retention	24
11	Contractor's Risks	21	32	Liquidated damages	25
12	Contractor to construct the works	21	33	Cost of Repairs	25
13	The works to be completed by the intended completion date	21		E. Finishing the contract	
14	Approval by the Assistant Executive Engineer	22	34	Completion	25
15	Safety	22	35	Taking Over	25
16	Discoveries	22	36	Termination	25
17	Access to the site	22	37	Payment upon Termination	26
18	Instructions	22	38	Property	26
	B. Time Control		39	Force Majeure Event	26
19	Program	22	40	Legal Provisions	26
20	Delays ordered by the Employer	23	41	Caution boards	26
21	Management Meetings	23	42	Tender Transparency Act	26
22	Early Warning	23			

SECTION 2

Additional Conditions of Contract

A. General

1. Definitions

1.1

Bill of Quantities means the priced and completed **Bill of Quantities** forming part of the Bid.

The **Completion Date** is the date of completion of the Works as certified by the Engineer in accordance with Sub Clause.35.1 of section 2.

The **Contract** is the contract between the Employer or his representative and the Contractor to execute, complete and maintain the Works. It consists of the documents listed in Clause 2.3 below.

The **Contractor** is a person or corporate body whose Bid to carry out the Works has been accepted by the Employer.

The **Contractor's Bid** is the completed Bidding document submitted by the Contractor to the Employer.

The **Contract Price** is the price stated in the Letter of Acceptance and thereafter as adjusted in accordance with the provisions of the Contract.

Days are calendar days; **months** are calendar months.

A **Defect** is any part of the Works not completed in accordance with the Contract.

The **Defects Liability Period** is the period of 1 year for BT roads and 2 years for CC roads from the completion of whole of the work.

Employer is Executive Officer of the Town Panchayat

The Executive Officer of the Town Panchayat or in his absence Assistant Engineer / Junior Engineer authorized by Employer is responsible for inviting tender, handling process, clarify issues related to tenders, signing of agreement and supervising the execution of the works and administering the Contract.

The **Tender Inviting Authority** is Executive Officer of the Town Panchayat

The **Tender Scrutiny Committee** is the committee of officers which will open, scrutinize and evaluates the bids.

Engineer means the Assistant Engineer/ Junior Engineer who is the designated project engineer for the Special Roads Programme

Equipment is the Contractor's machinery and vehicles brought temporarily to the Site to construct the Works.

The **Intended Completion Date** is the date on which it is intended that the Contractor shall complete the Works. The Intended Completion Date is specified in the Contract Data. The Intended Completion Date may be revised only by the **Executive Officer** by issuing an extension of time.

Materials are all supplies, including consumables, used by the contractor for Town Panchayat in the Works.

Plant is any integral part of the Works which is to have a mechanical, electrical, electronic or chemical or biological function.

The **Site** is the area defined as the road specified in the bid document. The date of handing over of the site is the date on which the work order is issued.

Site Investigation Reports are those which were included in the Bidding documents and are factual interpretative reports about the surface and sub-surface conditions at the site.

Specification means the Specification of the Works included in the Contract and any modification or addition made or approved by the Engineer.

Temporary Works are works designed, constructed, installed, and removed by the Contractor which are needed for construction or installation of the Works.

A **Variation** is an instruction given by the Engineer which varies the Works.

The **Works** are what the Contract requires the Contractor to construct, install, and turn over to the **Tender Inviting Authority**.

2. Interpretation

2.1 In interpreting these Conditions of Contract, singular also means plural, male also means female or neuter, and the other way around. Headings have no significance. Words have their normal meaning under the language of the Contract unless specifically defined. **The Executive Officer** will provide instructions clarifying queries about the Conditions of Contract.

2.2 If sectional completion is specified in the Clause 13 of Section 2, references in the Conditions of Contract to the Works, the Completion Date, and the Intended Completion Date apply to any Section of the Works (other than references to the Completion Date and Intended Completion date for the whole of the Works).

2.3 The documents forming the Contract shall be interpreted in the following order of priority:

- (1) Agreement
- (2) Letter of Acceptance, notice to proceed with the works
- (3) Contractor's Bid
- (4) Conditions of Contract including Additional Conditions of Contract
- (5) Specifications
- (6) Drawings and
- (7) Bill of Quantities

3. Language and Law

3.1 The language of the Contract and the law governing the Contract are stated in "English" only.

4. Engineer's Decisions

4.1 Except where otherwise specifically stated, the **Assistant / Junior Engineer** will decide contractual matters between the **Employer** and the Contractor representing the **Employer**.

5. Delegation

5.1 The **Employer** may delegate any of his duties and responsibilities to other people.

6. Communications

6.1 Communications between parties which are referred to in the conditions are effective only when in writing. A notice shall be effective only when it is delivered (in terms of Indian Contract Act).

7. Other Contractors

- 7.1 The Contractor shall cooperate and share the Site with other contractors, public authorities, utilities, and the **Employer** between the dates given in the Schedule of Other Contractors. The Contractor shall also provide facilities and services for them as described in the Schedule. The **Employer** may modify the schedule of other contractors and shall notify the contractor of any such modification.

8. Personnel

- 8.1 The Contractor shall employ the key personnel named in the Schedule of Key Personnel as referred to in the Annexure 'A' of Section 3, to carry out the functions stated in the Schedule or other personnel approved by the **Executive Officer**. The **Executive Officer** will approve any proposed replacement of key personnel only if their qualifications, abilities, and relevant experience are substantially equal to or better than those of the personnel listed in the Schedule.
- 8.2 If the **Executive Officer** asks the Contractor to remove a person who is a member of the Contractor's staff or his work force stating the reasons the Contractor shall ensure that the person leaves the Site within seven days and has no further connection with the work in the Contract.

9. Employer's and Contractor's Risks

- 9.1 The **Employer** carries the risks which this Contract states are **Employer's** risks, and the Contractor carries the risks which this Contract states are Contractor's risks.

10. Employer's Risks

- 10.1 The **Employer** is responsible for the excepted risks which are (a) in so far as they directly affect the execution of the Works in the risks of war, hostilities, invasion, act of foreign enemies, rebellion, revolution, insurrection or military or usurped power, civil war, riot commotion or disorder (unless restricted to the Contractor's employees), and contamination from any nuclear fuel or nuclear waste or radioactive toxic explosive, or (b) a cause due solely to the design of the Works, other than the Contractor's design.

11. Contractor's Risks

- 11.1 All risks of loss of or damage to physical property and of personal injury and death which arise during and in consequence of the performance of the Contract other than the excepted risks are the responsibility of the Contractor.

12. Contractor to Construct the Works

- 12.1 The Contractor shall construct and install the Works in accordance with the Specification and Drawings, and as per instructions of **Assistant / Junior Engineer**.

13. The works to be Completed by the Intended Completion Date

- 13.1 The Contractor may commence execution of the Works on the Start Date and shall carry out the Works in accordance with the program and complete the work as follows.

In case of Black Topping (BT) as well as Cement Concrete (CC) Roads, the following milestones have to be met

- a. Minimum one third of the value of work should be completed by the end of the 3rd month, and
- b. Work should be completed in all respects by the end of the 6th month.

If there is default in meeting either or both these deadlines, Liquidated damages @ 0.1% of the unfinished value of work (in relation to the two milestones) will be levied per day till their completion.

The period of completion shall be 6 months from the date of issue of Work Order to the successful contractor.

14. Approval by the Assistant Executive Engineer

- 14.1 The Contractor shall submit Specifications and Drawings showing the proposed Temporary Works to the **Assistant Executive Engineer**, who is to approve them if they comply with the Specifications and Drawings.
- 14.2 The Contractor shall be responsible for design of Temporary Works.
- 14.3 The **Assistant Executive Engineer** approval shall not alter the Contractor's responsibility for design of the Temporary Works.
- 14.4 All Drawings prepared by the Contractor for the execution of the temporary or permanent Works, are subject to prior approval by **Assistant Executive Engineer**, before their use.

15. Safety

- 15.1 The Contractor shall be responsible for the safety of all activities on the Site.

16. Discoveries

- 16.1 Anything of historical or other interest or of significant value unexpectedly discovered on the Site is the property of the Employer. The Contractor is to notify the **Executive Officer** of such discoveries and carry out the **Executive Officer's** instructions for dealing with them.

17. Access to the Site

- 17.1 The Contractor shall allow the **Executive Officer** and any person authorized by the Assistant Executive Engineer access to the Site, to any place where work in connection with the Contract is being carried out or is intended to be carried out and to any place where materials or plant are being manufactured / fabricated / assembled for the works.

18. Instructions

- 18.1 The Contractor shall carry out all instructions of the **Executive Officer**, which comply with the applicable laws where the Site is located.

B. Time Control

19. Program

- 19.1 Within the time stated in the Clause 13 of Section 2, the Contractor shall submit to the Engineer for approval a Program showing the general methods, arrangements, order, and timing for all the activities in the Works along with monthly cash flow forecast.
- 19.2 An update of the Program shall be a program showing the actual progress achieved on each activity and the effect of the progress achieved on the timing of the remaining work including any changes to the sequence of the activities.
- 19.3 The Contractor shall submit to the **Executive Officer**, for approval, an updated Program at intervals no longer than the period stated in the Clause 13 of Section 2. If the Contractor does not submit an updated Program within this period, the **Executive Officer** may withhold the amount stated in the Clause 31 of Section 2 from the next payment certificate and continue to withhold this amount until the next payment after the date on which the overdue Program has been submitted.

19.4 The **Executive Officer's** approval of the Program shall not alter the Contractor's obligations. The Contractor may revise the Program and submit it to the Engineer again at any time. A revised Program is to show the effect of Variations and Compensation Events.

20. Delays Ordered by the Employer

20.1 The **Executive Officer** may instruct the Contractor to delay the start or progress of any activity within the Works.

21. Management Meetings

21.1 Either the **Executive Officer** or the Contractor may require the other to attend a management meeting. The business of a management meeting shall be to review the plans for remaining work and to deal with matters raised in accordance with the early warning procedure.

21.2 The **Executive Officer** shall record the business of management meetings and is to provide copies of his record to those attending the meeting and to the Employer. The responsibility of the parties for actions to be taken is to be decided by the **Executive Officer** either at the management meeting or after the management meeting and stated in writing to all who attended the meeting.

22. Early Warning

22.1 The Contractor is to warn the **Executive Officer** at the earliest opportunity of specific likely future events or circumstances that may adversely affect the quality of the work, increase the Contract Price or delay the execution of works.

22.2 The Contractor shall cooperate with the **Executive Officer** in making and considering proposals for how the effect of such an event or circumstance can be avoided or reduced by anyone involved in the work and in carrying out any resulting instruction of the Engineer.

C. Quality Control

23. Identifying Defects

23.1 The **Assistant Executive Engineer** shall check the Contractor's work and notify the Contractor of any Defects that are found. Such checking shall not affect the Contractor's responsibilities. The **Assistant Executive Engineer** may instruct the Contractor to search for a Defect and to uncover and test any work that the **Assistant Executive Engineer** considers may have a Defect.

23.2 The contractor shall permit the Employer's Technical auditor to check the contractor's work and notify the **Assistant / Junior Engineer** and Contractor of any defects that are found. Such a check shall not affect the Contractor's or the Engineer's responsibility as defined in the Contract Agreement.

23.3 The contractor shall permit the State Quality monitoring Agency to check the contractor's work and notify the **Assistant / Junior Engineer** and Contractor of any defects that are found. Such a check shall not affect the Contractor's or the Engineer's responsibility as defined in the Contract Agreement

24. Tests

24.1 If the **Assistant / Junior Engineer** instructs the Contractor to carry out a test not specified in the Specification to check whether any work has a Defect and the test shows that it does, the Contractor shall pay for the test and any samples. If there is no Defect the test shall be a Compensation Event.

25. Correction of Defects

- 25.1 The **Executive Officer** shall give notice to the Contractor of any Defects before the end of the Defects Liability Period, which begins at Completion and is defined in the Clause 31 of Section 2. The Defects Liability Period shall be extended for as long as Defects remain to be corrected.
- 25.2 Every time notice of a Defect is given, the Contractor shall correct the notified Defect within the length of time specified by the **Executive Officer's** notice.

26. Uncorrected Defects

- 26.1 If the Contractor has not corrected a Defect within the time specified in the **Executive Officer's** notice, the **Assistant / Junior Engineer** will assess the cost of having the Defect corrected, and the Contractor will pay this amount.
- Note:-** Where in certain cases, the technical specifications provide for acceptance of works within specified tolerance limits at reduced rates, Engineer will certify payments to Contractor accordingly.

D. Cost Control

27. Bill of Quantities

- 27.1 The Bill of Quantities shall contain items for the construction, installation, testing, and commissioning work to be done by the contractor.
- 27.2 The Bill of Quantities is used to calculate the Contract Price. The Contractor is paid for the quantity of the work done at the rate in the Bill of Quantities for each item.

28. Payments

- 28.1 Part or complete Payment will be made EVERY MONTH by the Executive Officer based on the OUTTURN of satisfactory completion of work in the PREVIOUS MONTH and value of work executed shall be determined, based on the measurements and check measurements by the Engineers in the M.Book.
- 28.2 Items of the Works for which no rate or price has been entered in will not be paid for by the Employer and shall be deemed as covered by other rates and prices in the Contract.

29. Tax

- 29.1 The rates quoted by the Contractor shall be deemed to be inclusive of the sales and other taxes that the Contractor will have to pay for the performance of this Contract. The Employer will perform such duties in regard to the deduction of such taxes at source as per applicable law.

30. Currencies

- 30.1 All payments shall be made in Indian Rupees.

31. Retention

- 31.1 The Employer shall retain a sum equivalent to 5% of the value of the each bill as retention money from each payment due to the Contractor.
- 31.2 Out of the 5% of the retention amount, on issue of completion certificate for the work 2.5% will be released to the Contractor while the balance 2.5% will be retained during defect liability period (1 year for BT Roads and 2 years for CC Roads). The retained 2.5% will be released by the Executive Officer, after ensuring no liability in connection with work executed.

32. Liquidated Damages

The Contractor shall full fill two milestones viz.,

In case of Black Topping (BT) as well as Cement Concrete (CC) Roads, the following milestones have to be met

- a. Minimum one third of the value of work should be completed by the end of the 3rd month, and
- b. Work should be completed in all respects by the end of the 6th month.

If there is default in meeting either or both these deadlines, Liquidated damages @ 0.1% of the unfinished value of work (in relation to the two milestones) will be levied per day till their completion.

If the work is not completed even 45 days after the 6months period, the contract is liable for summary cancellation, Security deposit forfeited and contractor black listed.

However, as earlier mentioned, the employer can cancel the contract if the work is not executed as per the contract in the intermediate period also.

33. Cost of Repairs

- 33.1 Loss or damage to the Works or Materials to be incorporated in the Works between the Start Date and the end of the Defects Liability periods shall be remedied by the Contractor at the Contractor's cost if the loss or damage arises from the Contractor's acts or omissions.

E. Finishing the Contract

34. Completion

- 34.1 The Contractor shall request the Engineer to issue a Certificate of Completion of the Works and the **Executive Officer** will do so upon deciding that the Work is completed.

35. Taking Over

- 35.1 The Employer shall take over the Site and the Works within seven days of the **Assistant / Junior Engineer** issuing a certificate of Completion.

36. Termination

- 36.1 The Employer or the Contractor may terminate the Contract if the other party causes a fundamental breach of the Contract.

- 36.2 Fundamental breaches of Contract include, but shall not be limited to the following:

- a) the **Executive Officer** gives Notice that failure to correct a particular Defect is a fundamental breach of Contract and the Contractor fails to correct it within a reasonable period of time determined by the **Assistant / Junior Engineer**
- b) the Contractor does not maintain a security which is required;
- c) the Contractor has not completed even 45 days after the contract period
- d) if the Contractor, in the judgment of the Employer has engaged in corrupt or fraudulent practices in competing for or in the executing the Contract.

- 36.3 If the Contract is terminated the Contractor shall stop work immediately, make the Site safe and secure and leave the Site as soon as reasonably possible.

37. Payment upon Termination

37.1 If the Contract is terminated because of a fundamental breach of Contract by the Contractor, the **Assistant / Junior Engineer** shall issue a certificate for the value of the work done up to the date of the issue of the certificate, less other recoveries due in terms of the contract, less taxes due to be deducted at source as per applicable law and less the percentage to apply to the work not completed as indicated in the Clause 13 of Section 2. If the total amount due to the Employer exceeds any payment due to the Contractor the difference shall be a debt payable to the Employer.

38. Property

38.1 All materials on the Site, Plant, Equipment, Temporary Works and Works are deemed to be the property of the Employer, if the Contract is terminated because of a Contractor's default.

39. Force Majeure Event

39.1 No party is eligible to terminate the agreement due to force majeure events.

40. Legal Provisions

40.1 Bidder shall abide by all statutory legal provisions made in relevant Laws./ Acts / Rules including but not confined to the Child Labour Act, Factories Act, Industrial Disputes Act, etc. The Employer has the right to take action to invoke the Revenue Recovery Act to recover any amount due, wherever necessary.

40.2 Risk Insurance
The work executed by the contractor under this contract shall be maintained by the contractor's risk until the work is taken over by the Commissioner/Executive officer. The Government should not be liable to pay for any loss or damages occasioned by (or) arising out of fire, flood, volcanic eruptions, earth quake, other conclusion of nature and all other natural calamities risk arising out of act of God during such period and that the option whether to take insurance coverage (or) not to care such risks is left to the contractor.

41. Caution boards: "CAUTION: WORK IN PROGRESS ROAD CLOSED"

Warning Notice shall be placed at points in the neighborhood of the work where other roads join and cross the road and at such points as may be directed to enable motorists, cyclists, or vehicular traffic to avoid the obstructed road by taking alternative routes, extra cost will not be paid for any incidental items.

42. Tender Transparency Act

The Tamil Nadu Tender Transparency Act will be applicable for this tender.

SECTION - 3
Formats of Qualification Information

1. Qualification Information

The Applicant shall include with the Qualification schedule, details in the prescribed proforma vide Annexure "A" to "H".

- I. Annexure 'A' - Structure and Organization
- II. Annexure 'B' - Financial Capability Statement
- III. Annexure 'C' - Plant and Equipments
- IV. Annexure 'D' - Work experience (works completed)
- V. Annexure 'E' - Details of Abandonment of work Litigation / debarring done
- VI. Annexure 'F' - Affidavit on Non-judicial stamp paper
- VII. Annexure 'G' - Undertaking to abide by modified terms and Conditions, if any
- VIII. Annexure 'H' - Details of Technical Personnel under Regular Employment with the Applicant.

Annexure “A”

STRUCTURE AND ORGANISATION

1	Name of the Bidder	:	
2	Status	:	
	Individual contractor	:	
	Sole Proprietary Firm	:	
	Firm in Partnership	:	
	Private Limited Company	:	
	Public Limited Company	:	
3	Head Office/Registered office address with phone/ Fax Number / E-mail ID	:	
4	Local office (if any) address with Phone/ Telex / Fax Number	:	
5	Main line of Business [such as (Civil) Engineering Contractor / General Engineering Contractor/ Electrical Engineering Contractor etc, should be specified.]	:	
6	Name, position, status, capacity etc, of the Key personnel/ [directors of the company (Attach organization chart showing the structure of the company/firm)]	:	
7	Name, capacity and address of the signatory who has Signed the Qualification Application. Attested copy of authorization issued (either by power of attorney or as per articles of Partnership Deed/ Memorandum of Association) in favor of the signatory to sign the qualification Application price Tender/ Agreement should be appended.	:	

ANNEXURE "B"

FINANCIAL CAPABILITY

1	Name and address of the Applicant	:			
2	Income Tax Permanent Account No. C.I. H. No.	:			
3	TIN Number	:			
4	Annual turn over as per Income Tax returns filed for the past five years	:	TAX YEAR	Figures (Rs.)	Words (Rs)
		:	2005-2006		
		:	2006-2007		
		:	2007-2008		
		:	2008-2009		
		:	2009-2010		
5	Annual turn over as per audited statement of account duly certified by the Chartered Accountant during the preceding Five years (Attach attested copy of balance sheets)	:	TAX YEAR	Figures	Words
		:	2005-2006		
		:	2006-2007		
		:	2007-2008		
		:	2008-2009		
		:	2009-2010		
6	Working Capital				
	I. Balance in bank account (Rs.)	:			
	II. Unutilized overdraft / Credit facility in the Nationalized / Scheduled bank (Rs.)	:			

ANNEXURE "C"

DETAILS OF CONSTRUCTION EQUIPMENTS, TOOLS & PLANTS, VEHICLES THAT COULD BE DEPLOYED EXCLUSIVELY FOR THIS WORK

NAME OF APPLICANT:

Sl.No.	Name of equipment/ Tools and plants/vehicles	Total requirement for this work	Equipments owned by the Applicant		Equipments currently under lease, available with the Applicant				Equipments proposed to be taken on lease		
			Number	Year of purchase make and capacity	Present working condition	Number	Year of Manufacture, Make & Capacity	Present working condition	Number	Year of Manufac ture, Make & Capacity	Present working condition
	For CC Roads										
1	Concrete Mixers Or Mobile Batching Plant	3 Nos 1 No.									
2	Screed Vibrator	2 No.									
3	Water Lorry	1 No.									
	For B.T Roads										
1	Central Mixing Plant	1 No.									
2	Paver Machine	1 No.									
3	Tipper Lorry	4 Nos.									
4	Vibratory Roller	1 No.									
5	Static Roller	1 No.									
6	Vehicle Mounted Mechanical Sprayer	1 No.									
7	Water Lorry	2 Nos.									
	Embankment										
1	Chain Dozer	1 No.									
2	Excavator	1 No.									
3	Loader	1 No.									
4	Water Lorry	1 No.									
5	Roller 8 -10 Tonne	1 No.									

Note: For the equipments currently under lease with the Applicant, date of expiry of lease period shall be furnished

ANNEXURE "D"

DETAILS OF BT (OR) BTAND CC ROAD WORK(S) OF NOT LESS THAN 50% OF THE VALUE PUT TO TENDER UNDER A "SINGLE AGREEMENT" IN ANY ONE OF THE PRECEDING 'THREE" YEARS (2007-08,08-09,09-10) FOR GOVERNMENT DEPARTMENT/BOARD/GOVERNMENT UNDERTAKING

NAME OF BIDDER :

Sl. No.	Type and Nature of work	Location Village/ Town/Taluk/ District/State	Name and designation of the employer/ owner	Value of work as per Agreement Rs.	Agreement Number	Stipulated period of contract as per agreement	Date of commencement of the work	Date of actual completion of work	Reasons for delay in completion (If any)	Actual value of work executed as per final payment	Quality of work done*
1											
2											
3											
4											
5											
6											
7											

Note: a) Certificate issued by the Engineer - in - charge (not below the rank of Executive Engineer/ Project Engineer) of each of the work is to be appended.

* b) Please indicate whether the work is "Satisfactorily Completed "

Dated Signature of the applicant with seal

ANNEXURE “E”

**INFORMATION REGARDING CURRENT LITIGATION / DEBARRING / EXPELLING
OF APPLICANT OR ABANDONMENT OF WORK BY THE APPLICANT**

1. (a) Is the Applicant currently involved in any Arbitration/
litigation relating to any contract works Yes / No
- (b) If Yes, Details thereon
2. (a) Has the Applicant or any of it's constituent
partners been Debarred/Expelled by any agency
during the Yes / No
last “Five” years
- (b) If yes, Details thereon
3. (a) Has the Applicant or any of it's constituent Partners
failed to complete, any contract work during the past Yes / No
“Five” years.
- (b) If yes, give details thereon

Dated Signature of Applicant with seal

Note: If any information in this Annexure is found to be incorrect or concealed, the bid will be summarily rejected & price tender will not be opened.

Bidders Signature

ANNEXURE "F" AFFIDAVIT

(To be furnished in a Twenty Rupees Non-Judicial Stamp Paper duly Certified by Notary Public)

1. I/We the undersigned solemnly declare that all the statements made in the documents, records etc., attached with this application are true and correct to the best of my/our knowledge
2. I/We the undersigned do hereby certify that neither my/our firm/company nor any of it's constituent partners have abandoned any work/works of similar nature and magnitude in India, during the Last "Five" years.
3. I/We the undersigned do hereby certify that any of the contracts awarded to me/us has not been terminated rescinded, due to breach of contract on my/our part, during the last "Five" Years.
4. I/We the undersigned authorize(s) and request any bank/person/firm/corporation/Government Departments to furnish pertinent information deemed necessary and requested by the Tender Inviting Authority Kalappanaickenpatty Town Panchayat, NAMAKKAL District to verify the statement made by me/us or to assess my/our competence and general reputation.
5. I/We, the undersigned, understand(s) that further qualifying information / clarifications on the statement made by me/us may be requested by the Tender Inviting Authority Kalappanaickenpatty Town Panchayat, NAMAKKAL District and agree(s) to furnish such information/clarification within "SEVEN" Days from the date of receipt of such request from the Tender Inviting Authority Kalappanaickenpatty Town Panchayat, NAMAKKAL District.

Dated Signature of Applicant with Seal:

(To be signed by the officer authorized by the Firm/Company to sign on behalf, the Firm/Company with company's seal)

Note: - In case of sole proprietary concern, affidavit should be signed only by the sole proprietor.

(Title of the Officer)

(Title of the firm/Company) (Date)

The above named deponent has understood the contents well and solemnly and sincerely declared and affirmed by the deponent in my presence at-----and signed before me on this day of

(Seal)

(Signature of the Notary Public)

Bidders Signature

ANNEXURE "G"

UNDER TAKING

Under taking should be furnished in a Twenty Rupees Non-Judicial Stamp paper with the Qualification Application and certified by the Notary Public.

I/We

the applicant do hereby undertake that I/we will abide by the terms and conditions if any modified by the Tender Inviting Authority Kalappanaickenpatty Town Panchayat in the contract conditions subsequent to submission of Qualification Annexure/price tender or subsequent to execution of the agreement.

Place:

Date :

Signature of the bidder

The above named deponent has understood the contents well and solemnly and sincerely declared and affirmed by the deponent in my presence at ----- and signed before me -----on this day of -----.

Place:

Date:

Signature of the Notary Public with Seal

I/We the applicant do hereby undertake that I/we will abide by the terms and conditions set forth in the tender document and am / are willing to undertake the New Construction / Up gradation of roads Nos. in Package No / Kalappanaickenpatty Town Panchayat of Namakkal District under the Special roads programme 2010-11. at the rate of Rs./- (in words Rupees. Only) amounts to Rs/- (in words Rupees which Only).

Place:

Date :

Bidders Signature

ANNEXURE "H"

**Details of Technical Personnel Under regular employment of the applicant
who can be made available exclusively for this work**

Name of Bidder:

Sl. No.	Designation	Name	Educational Qualification	Under regular employment with Applicant since	Total Span of Experience	Salary being paid	Remarks
1	B.E Civil (or) equivalent Degree holder with 5 years experience (or) not less than two retired Sub Divisional Officer (Assistant Executive Engineer or Assistant Divisional Engineer)	1					
		2					
		3					
		4					
		5					
		6					
		7					
		8					
2	Diploma holders in Civil Engineering with 2 years of the experience (or) Four Retired Junior Engineers.	1					
		2					
		3					
		4					
		5					
		6					
		7					
		8					

**Model Letter of Acceptance,
Model Form of Agreement,
and
Model Work Order**

Letter of Acceptance

From

To

Executive Officer

Name and Address of the Successful Bidder

_____Town Panchayat

Roc. No.-----

_____ **(date)**

Sub:- "Special Road Programme 2010-11" - "Improvement / Laying of Cement Concrete Roads and Black Topping of Roads using Paver Machines (Package No: -----) – issue of Letter of Acceptance – Regarding.

Ref:- 1. Your Tender dated on 01.11.10
2. Town Panchayat Council Resolution No. -----dated-----

This is to notify you that your Bid dated 01.11.10 for execution of the "Improvement/Laying of Cement Concrete Roads and Black Topping of Roads using Paver Machines to (Name of the work) (Package No: -----) [File No.----] for the Contract Price of Rupees. _____
(_____) [amount in words and figures], as corrected and modified in accordance with the Instructions to Bidders' is hereby accepted.

2) You are hereby requested to furnish Security Deposit for an amount equivalent to 2% of the contract value (which includes Earnest Money Deposit already paid) within 15 days from the receipt of this Letter of Acceptance. In terms of clause 30 of the tender document, the Security Deposit should be valid up to 30 days from the date of expiry of Defects Liability Period. You are also required to execute an agreement for fulfillment of the contract in a Rs. 20/- Judicial Stamp Paper. If you fail to remit the required Security deposit and execute the agreement within 15 days, your tender is liable for cancellation and EMD forfeited without notice.

3. You are informed that this is only the letter of acceptance of your bid. **Formal work order for the work will be issued on remitting the 2% Security Deposit and execution of agreement.**

Executive Officer
-----Town Panchayat

Bidders Signature

Agreement Form

Agreement

This agreement, made the _____ day of _____ 20_____,
between _____
_____ [Executive
Officer] of the one part and

_____ [name and address of contractor]
(hereinafter called "the Contractor") of the other part.

Whereas the Executive Officer is desirous that the Contractor execute
**Improvement/Laying of Cement Concrete Roads and Black Topping of Roads using
Paver Machines (Package No: -----) [File No.]** (hereinafter called "the Works") and the
Executive Officer has accepted the Bid by the Contractor for the execution and completion
of such Works and the remedying of any defects therein, at a contract price of
Rs.....

NOW THIS AGREEMENT WITNESSETH as follows:

1. In this Agreement, words and expression shall have the same meanings as are respectively assigned to them in the Conditions of Contract hereinafter referred to, and they shall be deemed to form and be read and construed as part of this Agreement.
2. In consideration of the payments to be made by the Employer to the Contractor as hereinafter mentioned, the Contractor hereby covenants with the Employer to execute and complete the Works and remedy any defects therein in conformity in all aspects with the provisions of the Contract.
3. The Employer hereby covenants to pay the Contractor in consideration of the execution and completion of the Works and the remedying the defects wherein the Contract Price or such other sum as may become payable under the provisions of the Contract at the times and in the manner prescribed by the Contract.
4. The following documents shall be deemed to form and be read and treated as part and parcel of this Agreement, viz.:
 - i) Tender Document including the Contractor's Bid Documents and all other documents furnished by the bidder and submitted as part of the Bid;
 - ii) Conditions of contract (including Special Conditions of Contract);
 - iii) Specifications;
 - iv) Drawings;
 - v) Bill of Quantities;
 - vi) Letter of Acceptance;
 - vii) Work Order (to be issued)
5. Detailed conditions agreed in the tender document form part of the agreement. The services to be performed, timelines to be met with, penalty clauses for non performance, and the other stipulations will be as furnished herein:

Bidders Signature

- I. **Contract Period:** The Contract period is for 6 months from the date of issue of work order to the successful contractor. (In case of BT roads, if the work order is issued earlier to 15th December, 2010, 6 months' time for BT roads will commence from 15th December,2010, and for the CC roads from the date of work order).
- II. **Payment Schedule:** Part or complete Payment will be made every month by the Executive Officer based on the outturn of satisfactory completion of work in the previous month and value of work executed shall be determined, based on the measurements and check measurements by the Engineers in the M.Book.

III **Milestones and Liquidated Damages:** The work will have two milestones

In case of Black Topping (BT) as well as Cement Concrete (CC) Roads, the following milestones have to be met

- a. Minimum one third of the value of work should be completed by the end of the 3rd month, and
- b. Work should be completed in all respects by the end of the 6th month.

If there is default in meeting either or both these deadlines, Liquidated damages @ 0.1% of the unfinished value of work (in relation to the two milestones) will be levied per day till their completion.

IV **Machineries:** The bidder should own or lease Paver Machine and tie up with a Hot Mix plant in respect of the BT roads. The Hot Mix shall be delivered at the work site at 120° C. The detailed list of Machineries as detailed in the Tender document shall be made available at the work site.

V **Retention Money:** The Town Panchayat shall retain a sum equivalent to 5% of the value of the each bill as retention money from each payment due to the Contractor. Out of the 5% of the retention amount, on issue of completion certificate for the work 2.5% will be released to the Contractor, while the balance 2.5% will be retained during defect liability period (ie., 1 year for the BT Roads and 2 years for the CC Roads). The retained 2.5% will be released by the Executive Officer, after ensuring no liability in connection with work executed.

VI **State Quality Monitors:** In order to ensure quality of the work, third party checks and inspections by the State Quality Monitors will be taken up. Any defects pointed out by the State Quality monitors shall be attended by the Contractor at his own cost and rectified.

VII **Fraudulent Practices :** If it is found at any time during the tender process, award of contract, or during the contract period, that the Contractor has furnished false certificate or if the Contractor, in the judgment of the Employer has engaged in corrupt or fraudulent practices in competing for, getting the contract or in the

Bidders Signature

executing the Contract, the Contract will be summarily terminated and Criminal Proceedings will be initiated.

VIII **Termination of the Contract:** If the work is not completed even 45 days after the contract period (6 months period), the contract is liable for summary cancellation

IX **Defect Liability Period:** The defect liability period is 1 year for the BT roads and 2 years for CC roads.

In witness whereof the parties thereto have caused this Agreement to be executed the day and year first before written.

The Common Seal

_____ was hereunto affixed in the presence of:

Signed, Sealed and Delivered by the said

in the presence of:

Binding Signature of Employer (Executive Officer) _____

Binding Signature of Contractor

Work Order

From
Executive Officer
_____ Town Panchayat

To
Name and Address of the Successful
Bidder

Roc. No.----- (date)

Sub:- "Special Road Programme 2010-11" - "**Improvement/Laying of Cement Concrete Roads and Black Topping of roads using Paver Machines (Package No: ----)**" – issuing of notice to proceed with the work-Regarding.

Ref:- 1. Your Tender dated on 01.11.10
2. Town Panchayat Council Resolution No. -----dated-----
3. Letter of Acceptance _____ dated _____
3. Your Agreement dated-----

Pursuant to your furnishing the requisite Security Deposit as stipulated in ITB clause 30 and signing of the contract agreement for the work of **Improvement/Laying of Cement Concrete Roads and Black Topping of roads using Paver Machines (Package No: ---)** @ a Bid Price of Rs.-----, you are hereby instructed to proceed with the execution of the said works in accordance with the contract terms and conditions. The Contract Period is 6 months from the date of issue of work order. (In case the work order is issued earlier to 15th December 2010, 6 months' time for BT roads will commence from 15th December,2010, and for the CC roads, from the date of issue of work order).

You are hereby instructed to proceed with the execution of the above said work in accordance with the conditions stipulated as per the agreement. Your attention is drawn to the following specific conditions for strict compliance:

1. **Contract Period:** The Contract period is for 6 months. (If the work order is issued earlier, 6 months' time for BT roads will commence from 15th December,2010, and for the CC roads from the date of work order) from the date of issue of Work Order to the successful contractor.
2. **Payment Schedule:** Part or complete Payment will be made every month by the Executive Officer based on the outturn of satisfactory completion of work in the previous month and value of work executed shall be determined, based on the measurements and check measurements by the Engineer in the M.Book.
3. **Milestones and Liquidated Damages:** The work will have two milestones

In case of Black Topping (BT) as well as Cement Concrete (CC) Roads, the following milestones have to be met

- a. Minimum one third of the value of work should be completed by the end of the 3rd month, and
- b. Work should be completed in all respects by the end of the 6th month.

Bidders Signature

If there is default in meeting either or both these deadlines, Liquidated damages @ 0.1% of the unfinished value of work (in relation to the two milestones) will be levied per day till their completion.

4. **Machineries:** The bidder should own or lease Paver Machine and tie up with a Hot Mix plant in respect of the BT roads. The Hot Mix shall be delivered at the work site at 120° C. The detailed list of Machineries as detailed in the Tender document shall be made available at the work site.
5. **Retention Money:** The Town Panchayat shall retain a sum equivalent to 5% of the value of the each bill as retention money from each payment due to the Contractor. Out of the 5% of the retention amount, on issue of completion certificate for the work 2.5% will be released to the Contractor, while the balance 2.5% will be retained during defect liability period (ie., 1 year for the BT Roads and 2 years for the CC Roads). The retained 2.5% will be released by the Commissioner /Executive Officer, after ensuring no liability in connection with work executed.
6. **State Quality Monitors:** In order to ensure quality of the work, Third party checks and inspections by the State Quality Monitors will be taken up. Any defects pointed out by the State Quality monitors shall be attended by the Contractor at his own cost and rectified.
7. **Fraudulent Practices :** If it is found any time during the tender process, award of contract, or during the contract period, that the Contractor has furnished false certificate or if the Contractor, in the judgment of the Employer has engaged in corrupt or fraudulent practices in competing for, getting the contract or in the executing the Contract, the Contract will be summarily terminated and Criminal Proceedings will be initiated.
8. **Termination of the Contract:** If the work is not completed even 45 days after the contract period (6 months period), the contract is liable for summary cancellation
9. **Defect Liability Period:** The defect liability period is 1 year for the BT roads and 2 years for CC roads.

Executive Officer
-----Town Panchayat

Bidders Signature

Tender Document
"Special Roads Programme 2010-11 "

PRICE BID

Kalappanaickenpatty Town Panchayat

NAME OF THE WORK : Providing Cement Concrete Pavement for the cross streets (1) Kalappanaickenpatty Pudur, Vettuvagoundar Street, (2) Pudur Reddy Colony, (3) Thottiyapatty Arunthathiyar Street and Thottiyar Street at Kalappanaickenpatty Town Panchayat in Namakkal District. **Value Put to Tender Rs.26.91 Lakhs**

OFFICER INVITING BIDS : Executive Officer
Kalappanaickenpatty Town Panchayat
Namakkal District.

Bidders Signature

Price Bid Date :

Invitation for Bid No.

To:

Executive officer,
Kalappanaickenpatty Town Panchayat,

We, the undersigned, declare that:

(a) We have examined and have no reservations to the Bid Documents.

(b) We offer to execute in conformity with the Bid Documents for the work of
“Improvement/Laying of Cement Concrete Pavement (Package No: 1)”in
Kalappanaickenpatty Town Panchayat under the “Special Roads Programme
2010-11”.

(c) The total price of our Bid, excluding any discounts offered in item (d) below is

- (i) In figures :- Rs...../-
- (ii) In Words:- Rupees

(d) The discounts offered are

- (i) In figures :- Rs...../-
- (ii) In Words:- Rupees

(e) The net price of our bid, after discount offered in (d) above is

(i) In figures :- Rs...../-

(ii) In Words:- Rupees only

(f) Our Bid shall be valid for a period of **90 days** from the date fixed for the bid submission deadline in accordance with the Bidding Documents, and it shall remain binding upon us and may be accepted at any time before the expiry of that period.

(g) If our Bid is accepted, we commit to remit Security Deposit in accordance with the Bid Documents within the stipulated time.

Bidders Signature

SCHEDULE OF RATES AND APPROXIMATE QUANTITIES

1. The quantities given here are those upon which the item rate tender cost of the work is based, but they are subject to alternations, omissions, deductions or addition as provided for in the conditions of this contract and do not necessarily show the actual quantities of work to be done. The unit rates quoted below are those governing payment for extras or deductions or omissions according to the condition of the contract, as set forth in the Standard Specifications for roads and bridges with the MOST specifications and other condition of specifications of the contract.
2. It is to be expressly understood that the measured work is to be taken net (Not withstanding any custom or practice to the contrary) according to the actual quantities. When in places and finished according to the drawings, or as may be ordered from time to time by the Engineer in charge and the cost calculated by measurement or weight at the respective prices, without any additional charge for any necessary or contingent works concerned therewith. The rates quoted are for the finished works in situ and complete in every respect.
3. The description given in Schedule - A are to indicate the item of work only and need not be construed as full specification. The quoted rate shall be for carrying out the item as per standards and specifications described in the relevant MOST specification. The contractor shall take no advantage of any apparent error or omission in the Schedule - A description.
4. The Tenderers should quote their rates for the quantity and units specified under metric units under Schedule 'A'.
5. The contractor should sign all the pages of schedule 'A' enclosed in the tender document without any omission. Otherwise the tender will be liable for rejection as per the rules.

Executive Officer

Kalappanaickenpatty Town Panchayat

Bidders Signature

SCHEDULE 'A'

Package No. : 1

:

Name of the Work

Providing Cement Concrete Pavement for the cross streets (1) Kalappanaickenpatty Pudur, Vettuvagoundar Street, (2) Pudur Reddy Colony, (3) Thottiyapatty Arunthathiyar Street and Thottiyar Street at Kalappanaickenpatty Town Panchayat in Namakkal District. (Ward No. 2,3,6,12 & 13)

Value Put to Tender

Rs.26.91 Lakhs

Total

Rs.26.91 Lakhs

EMD

Rs.26,910/-

:

SI. NO	Probable Quantity in Figures	Description Of Work	Rate		Unit in Words	Amount
			In Figures	In Words		
1	2	3	4	5	6	7
1	738.00 M ³	Supplying and filling of well gravel including cost and conveyance of gravel to work site and all labour charges for stacking them to departmental gauge at road sides for premeasurement by the departmental officers and spreading and compacting in layers as directed by the dept officers. For 1m3 TNDSS NO:301 & 305			1m ³ (one Cubic Metre)	
2	158.00 M ³	Earthwork excavation in all soils and sub soils except hard rock requiring blasting with initial lead and lift including re-filling the sides of foundation in layer of 15 cm thick watering , ramming ,depositing the surplus earth in the premises as directed by departmental officers etc.,			1M ³ (One cubic Metre)	

Bidders Signature

		complete as per standard specification. as per SS 20 B TNDSS NO: 23&24VI (S2), VII 9,10				
3	471.00 M ³	Plain cement concrete Using 1:4:8 mix (One cement, four sand and eight aggregates) using 40 mm ISS HBG metal including cost and conveyance of all materials to work site and all labour charges for mixing, laying,consolidating and curing etc complete as per the standard specifications. TNDSS NO: 28 V, VI (S2) V,VI (S5A) VII			1M ³ (One cubic Metre)	
4	1990.00 M ²	Picking the damaged old B.T Surface 50mm to 100 mm thick including all labour charges and cost and conveyance of all materials to site etc., complete as per standard specification. MORTH 702			1M ² (One square Metre)	
5	542.00 M ³	Plain Cement concrete in 1:2:4 (one cement , two sand and four aggregate) mix using 20mm ISS hard broken granite metal including cost and conveyance of all materials to work site and all labour charges etc., for mixing laying , consolidating,finishing the surface and curring etc., complete complying with as per standard specifications. TNDSS NO: 30 V,VI (S3) VII-3			1M ³ (One cubic Metre)	

Bidders Signature

6	38.00 M ³	Plain Cement concrete in 1:3:6 (one cement , three sand and six aggregate) using 20mm Size ISS HBG including cost and conveyance of all materials to work site and all labour charges etc., for mixing laying, consolidating, levelling and curring etc., complete complying with as per standard specifications. TNDSS NO: 30 V,VI (S3) VII-3			1M ³ (One cubic Metre)	
7	50.00 M ²	Plastering in Cement mortar 1:5 Mix (One cement and Five sand) 20 mm thick including curring, cost and conveyance of all materials to site,and all labour charges etc complete as per standard specifications TNDSS NO: 61 V,VI (S4)			1M ² (One Square Metre)	
8	306.00 M ²	Supplying and Erecting Steel Centering for sides and soffits including supports and strutting upto 3.29 m height for plane surfaces such as RCC Slabs, Rectangular Beams, TEE or ELL Beams, Lintels, Bed blocks, Staircase waist and Landing slabs, Landing Beams, canopy etc., with all cross bracings using mild steel sheets of size 90cmx60cm and 10 gauge stiffened with welded MS angles of size 25mmx25mmx3mm for boarding laid over silver oak (CW) joists of size 10cmx6.5 cm spaced at about 90cm c/c and supported by causrina props of 10cm to 13cm dia spaced at 75cm c/c including all labour charges cost and conveyance of all materials to site etc., complete as per standard specifications. (for drain wall) With out strutting TNDSS NO: 30&463 V, VI			1M ² (One Square Metre)	

Bidders Signature

LEAD STATEMENT

S.No	Details of Materials	Location of Quarry	Lead in Kilometer
1	WELL GRAVEL (m3)	Local	5
2	GRITTY GRAVEL (m3)	Local	5
3	a)Bittumen (mt) 60/70 Grade	Chennai	407
4	b) Emulsion Bittumen	Erugkattur	310
5	90mm I.R.C. METAL (m3)	Kondampatty	13
6	75mm I.R.C. METAL (m3)	Kondampatty	13
7	63mm I.R.C. METAL (m3)	Kondampatty	13
8	53mm I.R.C. METAL (m3)	Kondampatty	13
9	46.5mm I.R.C. METAL (m3)	Kondampatty	13
10	45mm I.R.C. METAL (m3)	Kondampatty	13
11	37.50mm I.R.C. METAL (m3)	Kondampatty	13
12	26.50mm I.R.C. METAL (m3)	Kondampatty	13
13	25mm I.R.C. METAL (m3)	Kondampatty	13
14	22.4mm I.R.C. METAL (m3)	Kondampatty	13
15	13.20mm I.R.C. METAL (m3)	Kondampatty	13
16	11.20mm I.R.C. METAL (m3)	Kondampatty	13
17	6.70mm I.R.C. METAL (m3)	Kondampatty	13
18	6mm I.R.C. METAL (m3)	Kondampatty	13
19	5.6mm I.R.C. METAL (m3)	Kondampatty	13
20	4.75mm I.R.C. METAL (m3)&below	Kondampatty	13
21	40mm ISS HBG metal	Kondampatty	13
22	20mm ISS HBG metal	Kondampatty	13
23	12mm IRC HBG metal	Kondampatty	13
24	6mm IRC HBG Metal	Kondampatty	13
25	10 to 12 mm IRC HBG Metal	Kondampatty	13
26	Sand for mortar	47/8 SH Trichy Main road	56
27	Sand for Filling	47/8 SH Trichy Main road	56
28	Well Gravel	Local	5
29	Cement	At Site	-
30	Steel	Local	-
31	Country Wood Scandling up to 4.00m	Local	17
32	M.S. Sheet BG10	Local	17
33	M.S.Angle 25mm x 25mm x3mm	Local	17
34	Casurina Poles 10cm to 13cm	Local	17
35	Binding Wire	Local	17

SCHEDULE 'B'

Sl. No.	Drawing No.	Description	Date on which drawing was approved
1	2	3	4
1	1/1	Site Plan	4.10.2010
2	1/1	Road Cross Section	4.10.2010
3	1 /2	Site Plan	4.10.2010
4	1 /2	Road Cross Section	4.10.2010
5	1 /2	Drain Cross Section	4.10.2010
6	1/ 3	Site Plan	4.10.2010
7	1/ 3	Road Cross Section	4.10.2010

Name of Work : Providing Cement Concrete Pavement for the Cross Streets at Kalappanaickenpatty Pudur and Vettuvagoundar Street in Kalappanaickenpatty Town Panchayat.

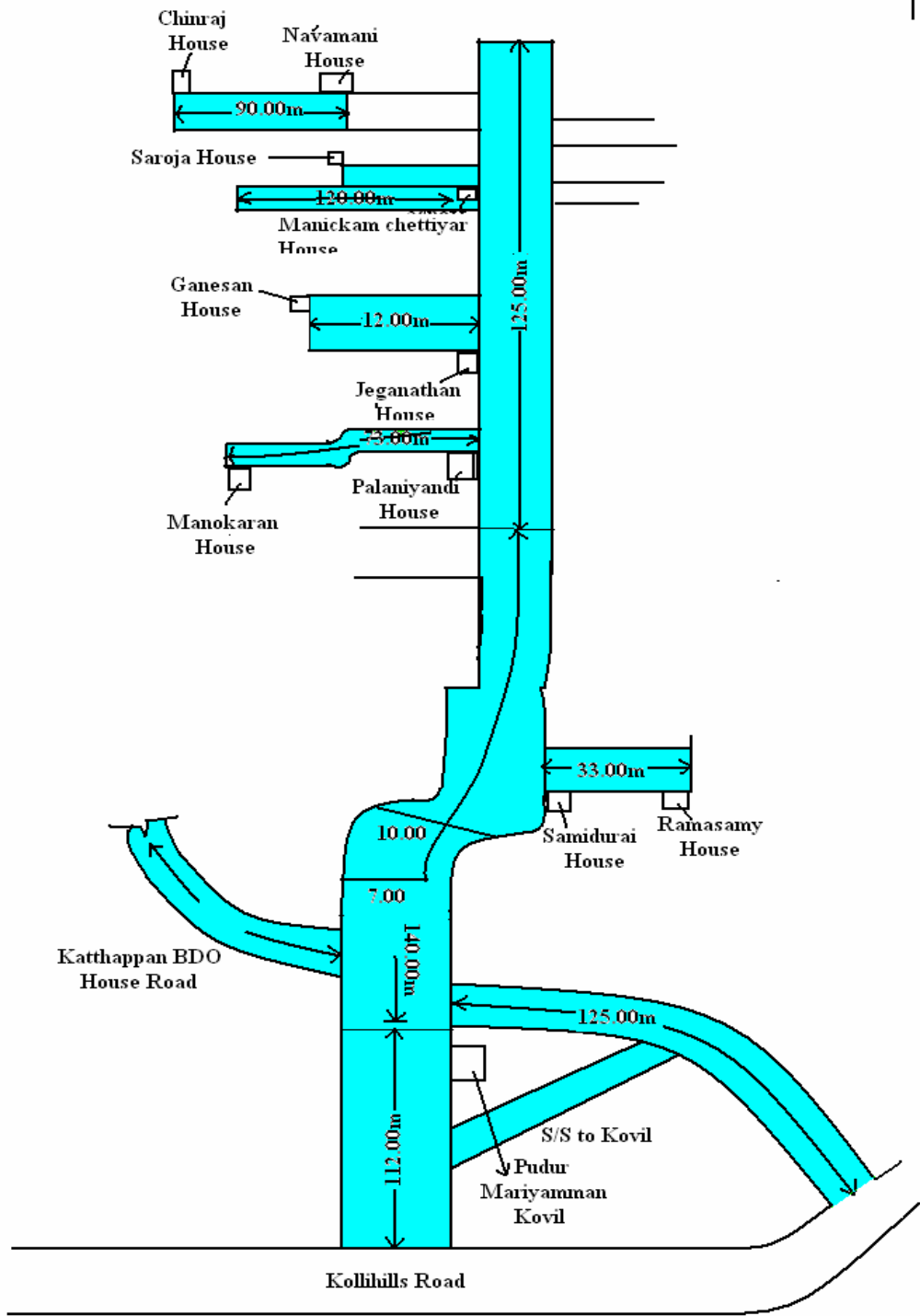
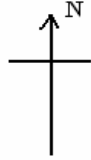

REFERENCE :
 Proposed CC Road

C.C Pavement - Cross Section

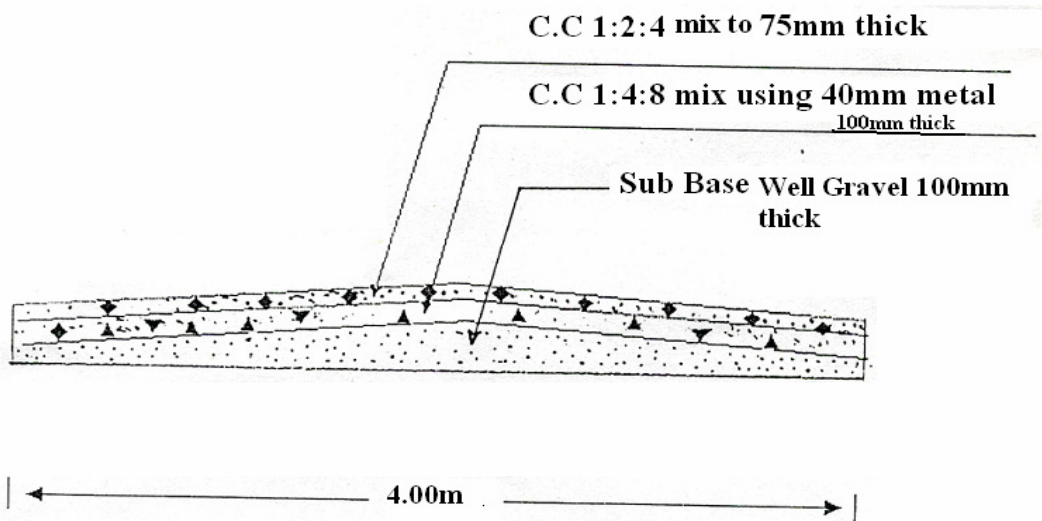

Name of Work : Providing Cement Concrete Pavement for the Cross Streets at Kalappanaickenpatty Pudur and Vettuvagoundar Street in Kalappanaickenpatty Town Panchayat.

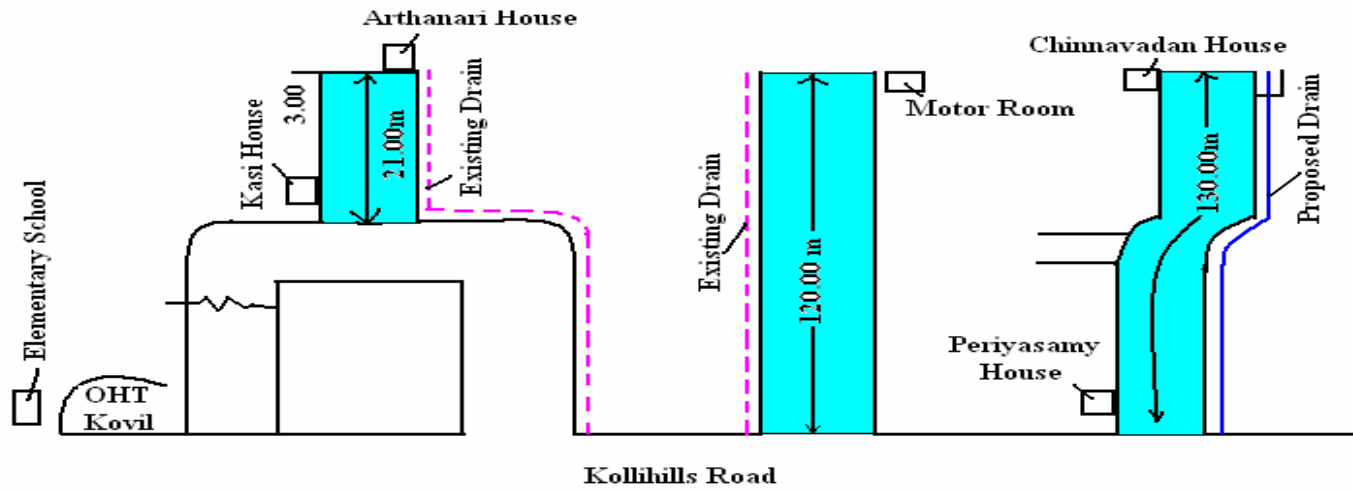
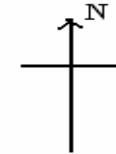

C.C Pavement - Cross Section

Name of Work : Providing Cement Concrete Pavement for the Cross Streets at Pudur Reddy Colony in Kalappanaickenpatty Town Panchayat.



<u>REFERENCE :</u>	
	Proposed CC Road
	Proposed Drain
	Existing Drain

C.C Pavement - Cross Section

Name of Work : Providing Cement Concrete Pavement for the Cross Streets at Pudur Reddy Colony in Kalappanaickenpatty Town Panchayat.

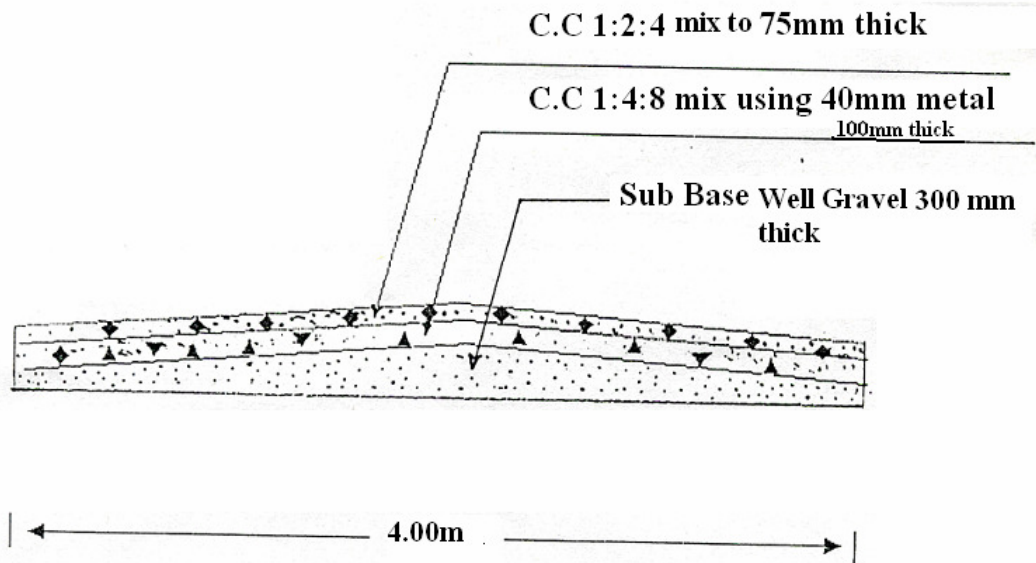

C.C Pavement - Cross Section

KALAPPANAICKEN PATTY TOWN PANCHAYAT, NAMAKKAL (DT).

NAME OF WORK:- Providing Cement Concrete Pavement for the Cross Streets at Pudur Reddy Colony in Kalappanaickenpatty Town Panchayat.

LENGTH :- 160m (NOT TO SCALE)
(all dimension are metre)

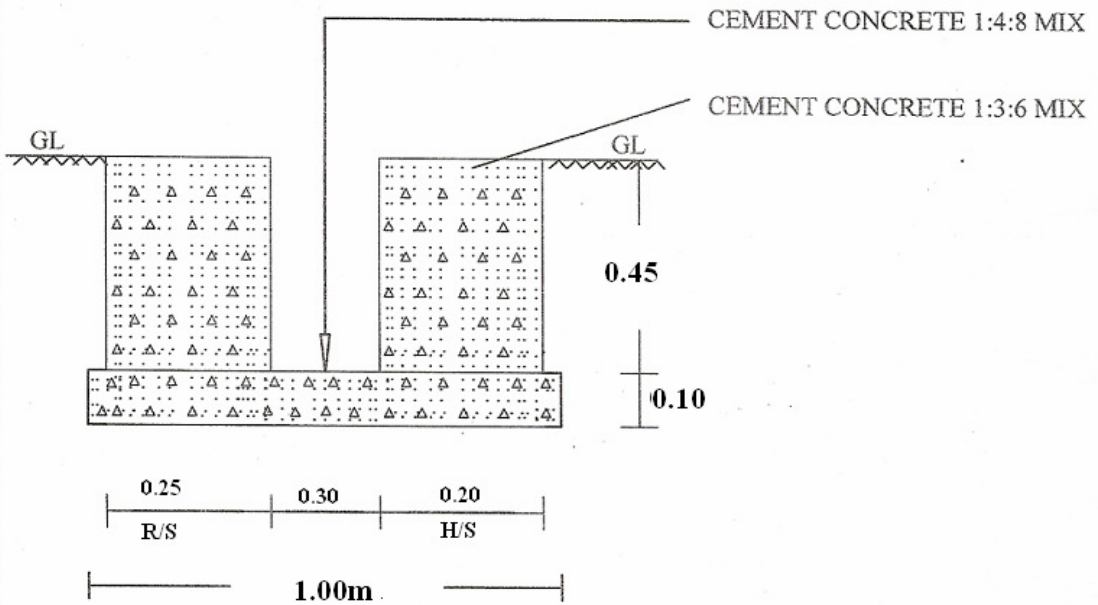

CROSS SECTION

Bidders Signature

Name of Work : Providing Cement Concrete Pavement for Thottiyapatty Arunthathiyar Street and Thottiyar Street in Kalappanaickenpatty Town Panchayat.

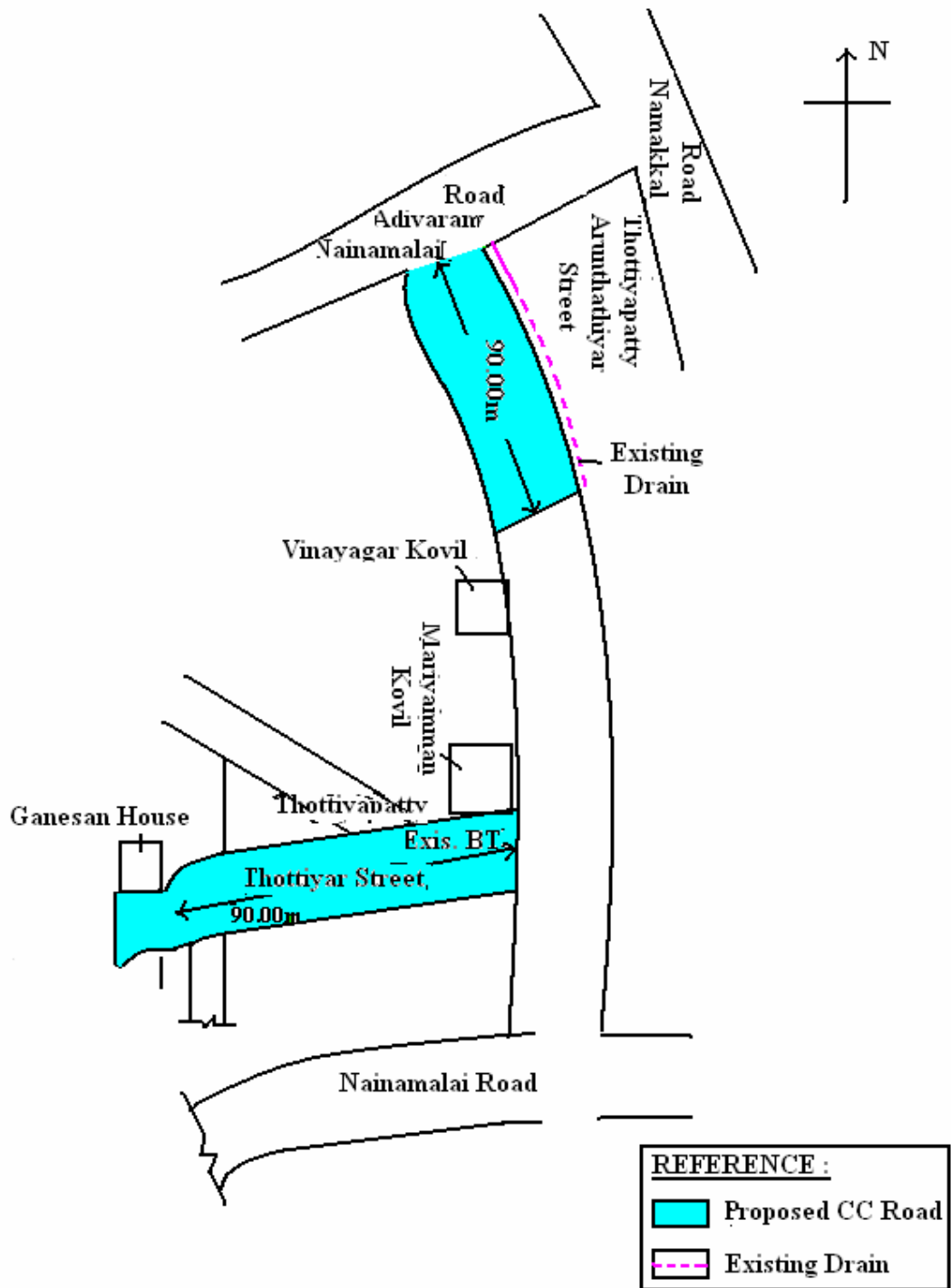

Bidders Signature

C.C Pavement - Cross Section

Name of Work : Providing Cement Concrete Pavement for Thottiyapatty
Arunthathiyar Street and Thottiyar Street in
Kalappanaickenpatty Town Panchayat.

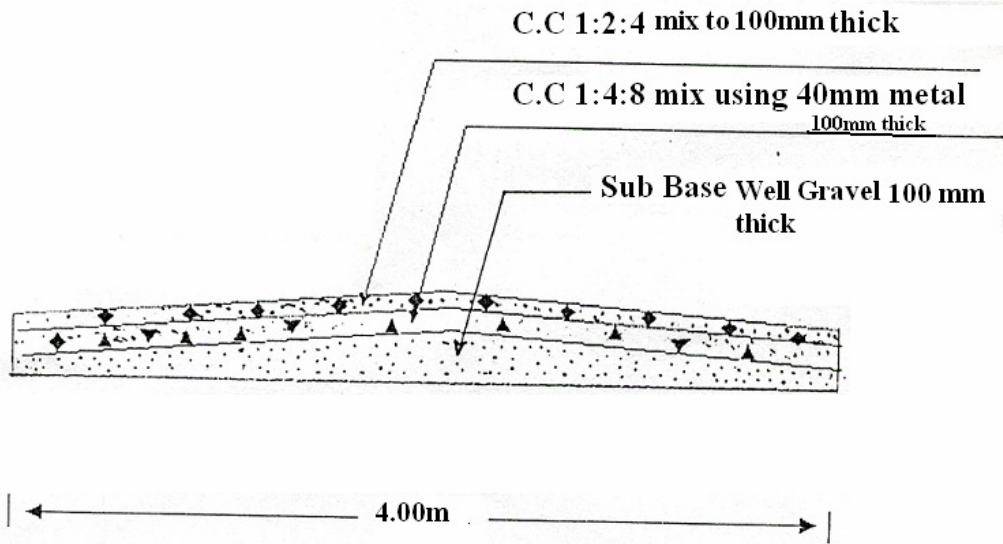

C.C Pavement - Cross Section